

Mounting systems for solar technology



ASSEMBLY INSTRUCTIONS  
**S-DOME SYSTEM**

GB

# TABLE OF CONTENTS

TABLE OF CONTENTS	2
THE COMPANY	3
SAFETY REGULATIONS	4
MATERIALS REQUIRED	5
TOOLS REQUIRED	8
ASSEMBLY	9

## PARTNER WITH A SYSTEM

With sophisticated, fully developed product ideas and obvious customer-orientation, K2 Systems is your friendly partner in the field of mounting systems for solar technology. International customers appreciate the tried and tested designs for use on roofs and in outdoor and individual solutions.

Mounting systems from K2 Systems impress with their attractive design and many well thought-out details. High grade materials and quality workmanship guarantee outstanding functionality and durability.

Our products consist of few yet perfectly matching components - this reduces the amount of material used, simplifies assembly while saving time and money.

As an energetic, experienced company, and in keeping with the times, we benefit from cooperation as partners in order to ensure the dynamic development of our company. The experiences from the personal dialogue with our customers forms the basis for permanent optimisation of our range of products. The team of K2 Systems looks forward to a successful cooperation with you.

## TESTED QUALITY - MULTIPLE CERTIFICATIONS

K2 Systems stands for secure connection, highest quality and precision. Our customers and business partners have already known that for a long time. Independent institutes have tested, confirmed and certified our capabilities and components.



# GENERAL SAFETY INSTRUCTIONS

Please be aware that our General Assembly Regulations must be adhered to.





They can be viewed under <http://www.k2-systems.uk.com/downloads/product-information.html>

In general, the following applies:

- Systems may only be installed and put into use by people who can ensure the proper carrying-out of the work due to their technical suitability (e.g. training or occupation) and/or experience.
- Before assembly, it must be checked that the product meets the local static requirements. With On-Roof systems it is mandatory to check the load bearing capacity of the existing roof/roof structure as well as the suitability of any affected constructive roofing layers such as insulation etc..
- National and local building regulations, standards and environmental regulations are always to be adhered to.
- Work safety and accident prevention regulations and corresponding standards and regulations of occupational associations are to be adhered to! In particular, it is to be ensured that:
  - Safety clothing is worn (especially safety helmets, work shoes and gloves).
  - For work on roofs, the regulations for working on roofs are to be adhered to (e.g. use of anti-fall guards, scaffolding with arrestor equipment from an eaves height of 3m etc.)
  - Presence of two people is vital for the entire course of the assembly, so that swift help can be ensured in the case of an accident.
- K2 mounting systems are constantly being developed further. Because of this, assembly procedures can change. Therefore, before assembly, always check that the assembly instructions are up-to-date under <http://www.k2-systems.uk.com/downloads/product-information.html>. We can also send you the latest version on request.
- The assembly instructions of the module manufacturer are to be adhered to.
- The grounding must be prepared on site (if necessary use lightning protection clamp).
- During the entire assembly time it is to be ensured that at least one copy of the assembly instructions is available on site.
- In the event of non-adherence to our General Safety Instructions and if competitor's parts are built in or attached, K2 Systems GmbH reserves the right to refuse liability.
- With disregarding our general installation and assembly instructions and not using all system components and assemblies according to these instructions as well when components are used, which were not obtained from us, K2 Systems is not liable for any resulting defects and damages. Warranty is excluded in such cases.
- If all safety instructions are adhered to and the system is correctly installed, there is a product warranty entitlement of 12 years! In this context we strongly recommend to also read our terms of guarantee which can be viewed under <http://www.k2-systems.uk.com/downloads/product-information.html>. We can also send them to you on request.
- The dismantling of the system takes place according to the assembly steps, in reverse order.
- K2 components made of stainless steels are available in different corrosion resistance classes. In every case, the expected corrosion exposure of each structure or component must be checked.

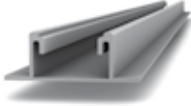
## ESSENTIAL: THE MATERIALS REQUIRED

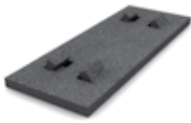
In order to install the K2 Systems S-Dome installation system, the following listed system components are essential. The piece quantities are calculated on the basis of the respective requirements. The listed item numbers facilitate the comparison of items.

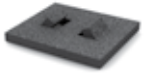
	<b>Mounting Rail K2 SpeedRail 22; 6,10 m</b>   1001163 Material: aluminium EN AW-6063 T66
	Alternatively: Mounting Rail K2 SpeedRail 4,20 m   1003379 Mounting Rail K2 SpeedRail 2,10 m   1003933
	<b>K2 FlatConnector Set</b>   1006039 The set consists of: → 1 FlatConnector, aluminium → 2 Allen bolt M8x20 (1000190), WS 6 mm, stainless steel A2 → 2 Lock washer S8 (1000473), stainless steel A2 → 2 M K2 Slot nut with clip (1001643), stainless steel and PA
	<b>K2 Dome S1000</b>   1005841 Width: 90 mm Material: aluminium EN AW-6063 T66
	<b>K2 Building protection mat Dome Alu</b>   2001695 470x180x18 mm Material: PUR bound rubber granules with aluminium triplex foil, laminated
	Alternativ: K2 Building protection mat Dome   2001696 470x180x18 mm Material: Unlaminated PUR-bonded rubber granulate
	The respective use of a laminated or unlaminated building protection mat depends on the type of roof membrane and must thus be checked on site.
	<b>K2 Dome SD</b>   1005842 Width: 90 mm Material: aluminium EN AW-6063 T66
	<b>K2 Building protection mat Dome SD Alu</b>   2001739 160x180x18 mm Material: PUR bound rubber granules with aluminium triplex foil, laminated
	Alternatively: K2 Building protection mat Dome SD   2001740 160x180x18 mm Material: Unlaminated PUR-bonded rubber granulate
	The respective use of a laminated or unlaminated building protection mat depends on the type of roof membrane and must thus be checked on site.



### K2 Washer 8,4x30x1,5 mm

| 1000273

Material: stainless steel A2



### K2 Windbreaker Dome S1000

| 1005843

For module length between 1601 and 1700 mm

Length: 1700 mm

Material: aluminium

Alternatively: K2 Windbreaker Dome S1000 1600 mm

| 2001119

For module length between 1550 and 1600 mm

Length: 1600 mm

Material: aluminium



### K2 Allen bolt

| Artikel-Nummer  
anlagenspezifisch

M8 DIN EN ISO 4762

Material: stainless steel A2, WS 6 mm



### K2 Lock washer DIN EN 10151

| 1000473

Material: stainless steel A2



### M K2 Slot nut with clip

| 1001643

Material: stainless steel, PA



### K2 Module End Clamp Standard Set

| Artikel-Nummer  
anlagenspezifisch

The set consists of:

- 1 Module End Clamp Standard, Aluminium plate finished/ black anodized
- 1 Allen bolt M8, WS 6 mm, stainless steel A2
- 1 M K2 Slot nut with clip (1001643), stainless steel and PA
- 1 Lock washer S8 (1000473), stainless steel A2
- 1 spring, stainless steel



### K2 Module Middle Clamp Standard Set

| Artikel-Nummer  
anlagenspezifisch

The set consists of:

- 1 Module Middle Clamp, Aluminium plate finished/ black anodized
- 1 Allen bolt M8, WS 6 mm, stainless steel A2
- 1 M K2 Slot nut with clip (1001643), stainless steel and PA
- 1 Lock washer S8 (1000473), stainless steel A2
- 1 spring, stainless steel

Alternatively: K2 Module Middle Clamp XS Set



## OPTIONAL COMPONENTS FOR BALLASTING:



**K2 Dome Scale**  
For taking up of ballast  
Material: aluminium

| 1005838



**K2 Dome Scale XL**  
For taking up of ballast  
Material: aluminium

| 2001679

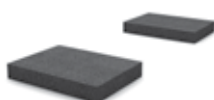

**K2 Building protection mat Scale Alu**  
300x140x18 mm

Material: PUR bonded rubber granules laminated with Alu-Triplex foil,  
under side selfadhesive, with 2 perforation cut

| 2001726

Alternatively: K2 Building protection mat Scale  
300x140x18 mm

Material: unlaminated PURbonded rubber granulate,  
under side self-adhesive, with 2 perforation cut

| 2001727

The respective use of a laminated or unlaminated building protection mat  
depends on the type of roof membrane and must thus be checked on site.



**K2 Dome Porter 1750 mm**  
For taking up of ballast

as a pair of L-Profiles to carry required ballast as concrete slabs or similar  
Material: aluminium

| 2000081

Alternatively: K2 Dome Porter 2050 mm

| 2001140



**K2 Dome Porter Screw Set**  
(optional to the K2 Dome Porter) one set per Porter

The set consists of:

- 2 M K2 slot nut with clip (1001643), stainless steel, PA
- 2 Allen Bolt M8x20 (1000190), WS 6 mm, stainless steel A2
- 2 Lock washer S8 (1000473), stainless steel A2

| 2000155

## AT A GLANCE: OVERVIEW OF THE TOOLS

K2 Systems mounting systems are designed to ensure effortless assembly. Only the tools that are required are not included in the scope of supply. Here we have listed them together for ease of reference.



Torque wrench

WS 6 mm  
(WS= wrench size)

---



Chalk line

---



Measuring tape



## IN GENERAL:

- ↪ K2 components made of stainless steels are available in different corrosion resistance classes. It needs to be checked in any case, which exposure to corrosion is to be expected for the respective building or building element.
- ↪ The General Installation Instructions must be adhered to.  
These can be found at: <http://www.k2-systems.uk.com/downloads/product-information.html>
- ↪ This system can be used on all established flat roof constructions with a pressure resistant substrate (>80 KN/m<sup>2</sup>) and a roof pitch of up to 5°. With any roof pitch of more than 3° the system additionally has to be mechanically fastened. The inclination of the Dome systems is 10°.
- ↪ Any structural-physical aspects are to be observed. In case of any doubts an expert adviser (i.e. structural engineer) has to be consulted
- ↪ Prior to placing down the SpeedRail as a base rail a protection layer shall be used between the roof covering and the rail to avoid any damages to the roof covering. Place the Speedrail onto the protection layer without penetrating the roof. The compatibility of the protection layer with the respective roof covering has to be checked by the installer. The protection layer doesn't form a part of the mounting system but is strongly recommended.
- ↪ The mounting rails and the protection mats/layer shall be clean and dry before installing.
- ↪ The roof covering shall be clean and level. If necessary any unevenness has to be levelled out or removed.
- ↪ The minimum distance to roof edges is 500mm and 300mm to all other obstructions (i.e. skylights, vents or similar).
- ↪ At least 1 row of two modules must be installed consecutively in order to use this system.
- ↪ The module distance according to the planning specifications of K2 Systems must be adhered to.
- ↪ The K2 S-Dome System is suitable for modules with a frame height of 30 - 50 mm.  
This system is not suitable for thin-film modules.
- ↪ Modules with a length of 1550 bis 1700 mm and a width of 950 to 1100 mm can be used.
- ↪ A thermal expansion gap of minimum 30mm and maximum of 150mm has to be provided for after max. 13.50m in module row direction as well as in direction of the base rail(s). It is essential that the system and its components don't block the draining of rain water.
- ↪ This assembly instructions are valid only for flat roofs with maximum pitch of 5 degrees.

## IN GENERAL:

- It is essential to clarify, from the start, whether there is a module manufacturer's approval available for the clamping on the short side of the installation system S- Dome S1000. You can obtain the approval list from your customer consultant or at [www.k2-systems.com](http://www.k2-systems.com). If no module approval is available, or if the occurring loads exceeding 2750 Pa, the alternative S-Level 2.11 installation system must be used!
- If required, paving blocks can be inserted in the base plate of the Scale Dome for ballasting on the SpeedRail / SpeedRail. For higher ballast we recommend using the K2 Porter.

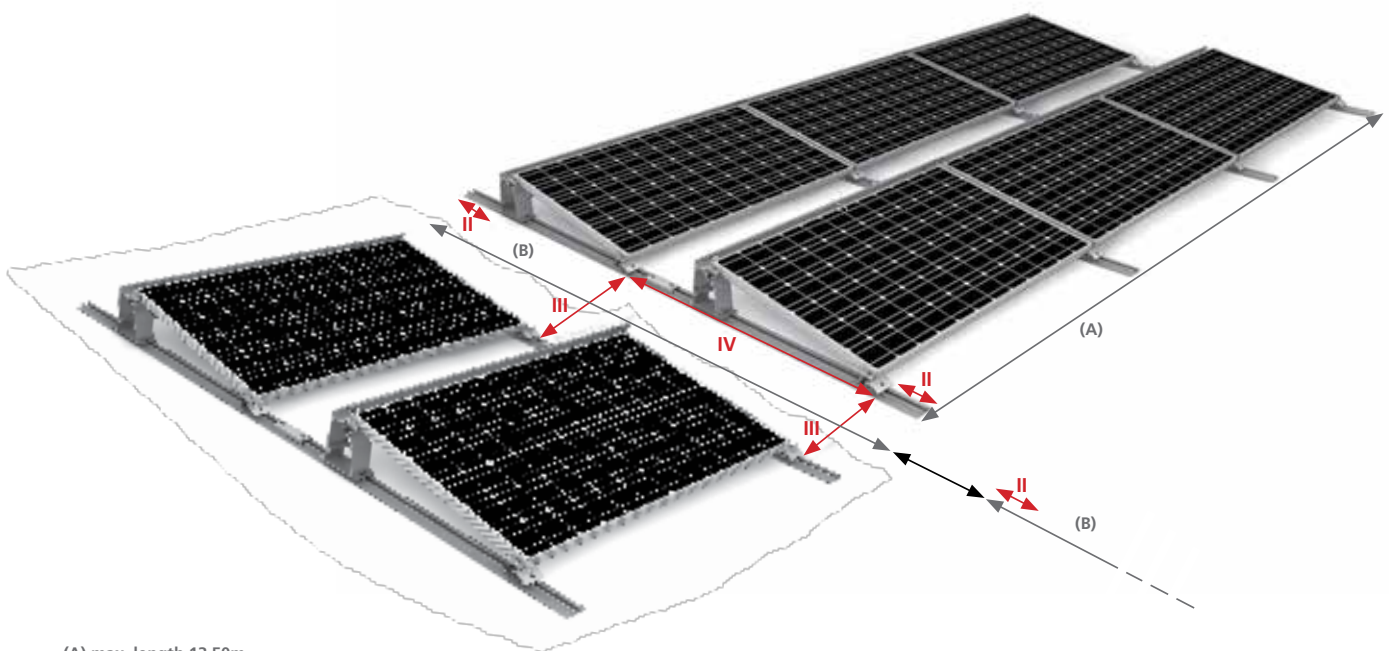

- (A) max. length 13.50m
- (B) max. length 13.50m
- (C) Distance between rails according K2Base
- II min. 20mm
- III 90mm with Porter rails / 113mm with K2Scales / 620mm on both sides with K2Scale XL
- IV calculated distance accord. K2Base

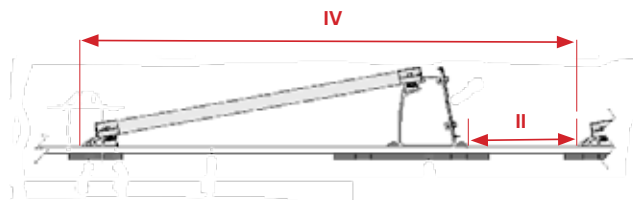

# INSTALLATION OF S-DOME SYSTEM: STEP BY STEP

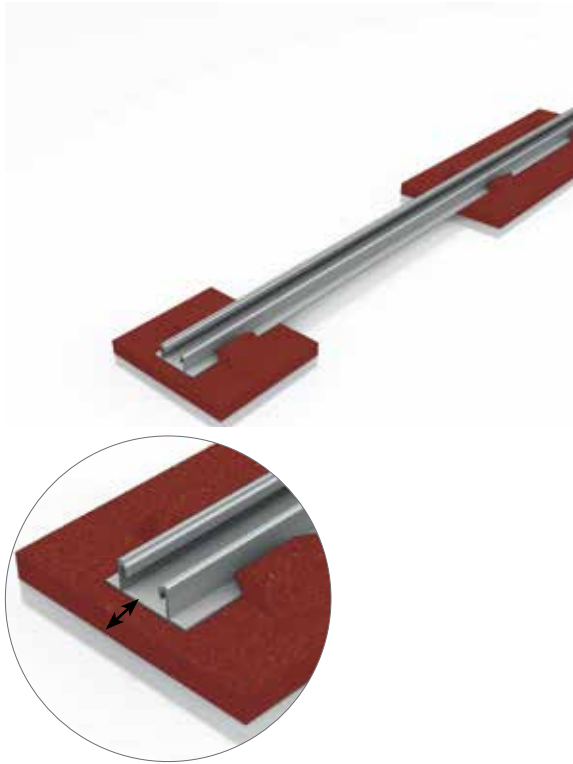

1  
of 7

## POSITION SPEEDRAIL

Prior to placing down the SpeedRail as a base rail a protection layer shall be used between the roof covering and the rail to avoid any damages to the roof covering. With membrane roofs the Aluminium-coated side shall face downwards. Place the Speedrail onto the protection layer without penetrating the roof. The protection mats have to be placed under the load bearing components Dome S1000, Dome SD and Dome Scale.

Position the protection mats according the requirements of the array. The spacing between the mats/base rails is determined by the module dimensions (module length + 20mm). ,Connect' the K2SpeedRails to the protection mats via the pre-cut WINGS.

The rail ends of the K2SpeedRails must not protrude the protection mats.

Materials required: K2 SpeedRail, building protection mat Dome 470x180x18 mm



2  
of 7

## INSTALL RAIL CONNECTORS

Two SpeedRails are connected at the rail joint using a rail connector. This locks the SpeedRails in the longitudinal direction. Insert 2 M K2 slot nuts in the rail and turn 90° clockwise to lock. Fasten rail connectors with two Allen bolt M8 and one locking washer each. The connector should be between the Dome S1000 and Dome SD.

If the rail lengths permit, the rail joint can also be positioned directly below the Dome S1000 without a rail connector. However, it must be ensured that the joint is between the two fittings and under no circumstances directly at the screw position.

Torque 14 Nm

Materials required: FlatConnector Set



3  
of 7

### FIT DOME S1000

Insert two M K2 slot nuts in the rail and turn 90° clockwise until they lock. Thereafter, position the Dome S1000 on the rail. Position the protection mat that two WINGS are under the Dome S1000. Only then fasten the Dome S1000 with two Allen bolts M8x20 mm and locking washers.

Torque: 16 Nm

Materials required: Dome S1000, M K2, Allen bolt M8x20, S8 locking washer



4  
of 7

### FIT DOME SD

Insert one M K2 slot nut in the rail and turn 90° clockwise until it locks. Place the Dome SD onto the rail and align as per the adjacent figure. The distance between Dome SD and Dome S1000 is approximately equal to the module width. Before fastening care should be taken that the protection mat Scale 300x140x18 and its WINGS are under the Dome SD and the rails at the array edges do not protrude. Finally the Dome SD is fastened with an Allen bolt and locking washer.

Materials required: Dome SD, M K2, Allen bolt M8x20, S8 locking washer, building protection mat Dome SD 160x180x18 mm

Ballast in kg	items required
up to 5 kg	no additional item required
5,1 kg to 15 kg	K2 Scale required
15,1 kg to 50 kg	One K2 Scale XL is required (on one side only)
50,1 kg to 100 kg	two K2 Scale XL are required (on both sides)
from 100.1 kg	A pair of K2 Porters under every module required

4b  
of 7

### OPTIONAL: BALLASTING THE SYSTEM

For some roof areas the system might need to be additionally ballasted against any wind suction that may occur. In case of necessary ballast the following additional items (see left side) shall be used:

#### Ballasting without additional items:

If only light ballasting up to 5 kg is required, a single ballast stone can be inserted directly into the hollow chamber of the Dome S1000.

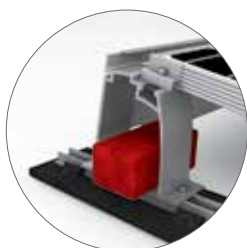



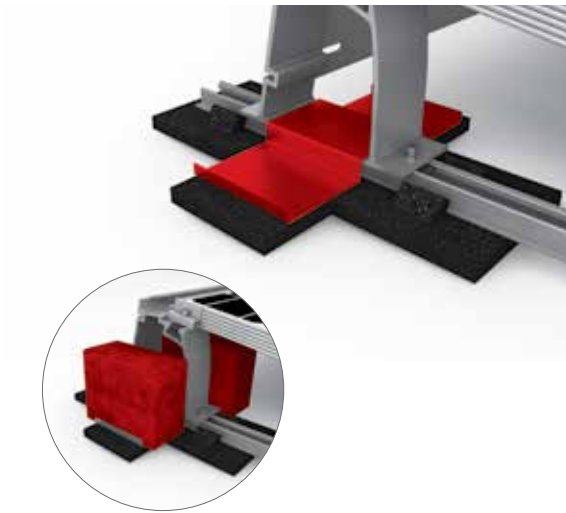

### Ballasting with K2 Scale::

Place the K2Scale into the hollow chamber of the Dome S1000. In the area of the K2 Scale the roof covering has to be protected with a protection mat Scale 300x140x18mm. To do so the protection mat has to be separated at its perforation and each half placed under the K2Scale. Depending on the necessary ballast the K2Scale can take up to four ballast bricks (dimensions lwxh 200x100x80mm) according the adjacent illustration. In case the Dome Scale XL is used, two protection mats Scale 300x140x18mm shall be used under the Dome Scale XL. Depending on necessary ballast the Dome Scale XL can take up to two concrete slabs (dimensions LxWxH 500x500x50 mm).

Dome Scale or Dome Scale XL, stones for ballasting, building protection mat 300x140x18 mm

### Ballasting with K2 Porters:

Fix each L-Profile with Allen Bolt, washer and slot nut to the SpeedRail. Torque moment 16 Nm. The distance between the porters shall be chosen according to the dimension of the concrete slabs.

Required material: K2 Porter (pair), K2 Porter screw set (pair)

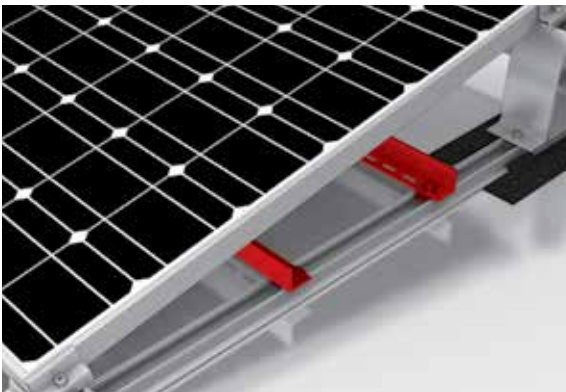

## 5 of 7 POSITION MODULES AND DOME SD

The module is laid horizontally, in the centre of two S1000 Domes. The specially affixed bars serve as a stop. Thereafter, the module is positioned on the Dome SD. The only loosely fastened Dome SD together with the protection mat SD 160x180x18 are pushed towards and against the module and then fastened. Before fastening care should be taken that the WINGS of the protection mat are under the Dome SD and the rails at the array edges do not protrude. Torque 16 Nm.

### Attention:

**Only modules approved for corner clamping may be used, see on the short side, see point „GENERAL RULES“ on page 12. Please take care not to cover any drainage holes in modules, as otherwise potential condensation cannot run off.**

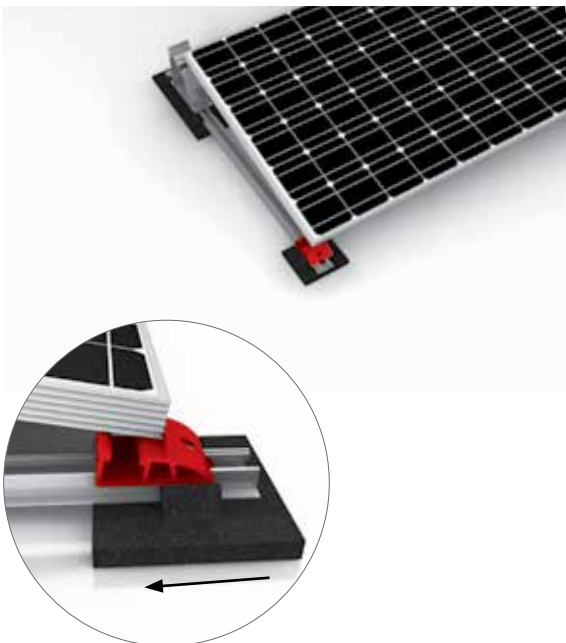



6  
of 7

## FASTEN MODULE

First, insert the M K2 slot nut into the nut of the Dome SD and the Dome D1000 and turn 90° clockwise. Screw the modules at the end of each row with module end clamps, Allen bolt M8 and S8 locking washers into the slot nuts. If the module end and mid clamp set is supplied, fasten the entire set in the groove.

Use two standard module middle clamps each between two modules which are also fastened with Allen bolt M8 screws and S8 locking washers in the M K2 slot nuts.

Alternatively, XS mid clamps can be used. However, longer screws must be used in this case. With XS middle clamps the Allen bolt length is defined by the module frame height +15mm. Torque: 14 Nm.

Materials required: Module end/ mid clamp Set

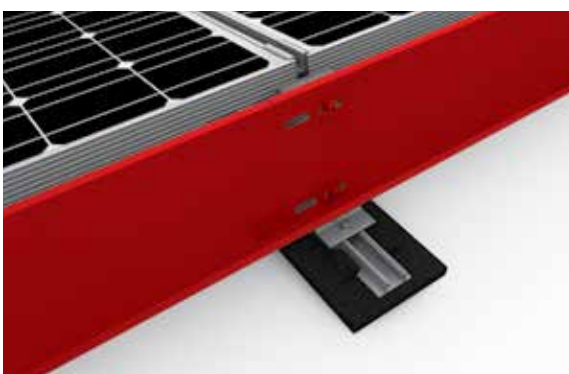

7  
of 7

## INSTALL THE WINDBREAKER

First position the upper fold of the symmetrical windbreaker on the bar of the Dome S1000. The foiled surface must face outwards. We recommend removing the foil once installation is completed.

Align the windbreaker against the module edge and fasten with the DIN 912 M8 hexagon socket screws with the aid of the elongated holes and washers in the screw channel. When two windbreakers overlap, position the plates in such a way that the screws can be screwed in the screw channel with the aid of the elongated holes. For this a washer must be used.

It must be ensured that the last windbreakers in a row do not project over the Dome S1000.

Torque 16 Nm

Materials required: Dome S1000 Windbreaker, hexagon DIN 912 M8 x 16 hexagon socket screw 8.4 x 30 x 1.5 washer

### Attention:

**If no module manufacturer's approval is available for clamping on the short side of the module, or if the occurring loads exceed 2750 Pa, the alternative K2 S-Level 2.11 installation system must be used!**

**Please take care not to cover any drainage holes in modules, as otherwise potential condensation cannot run off.**

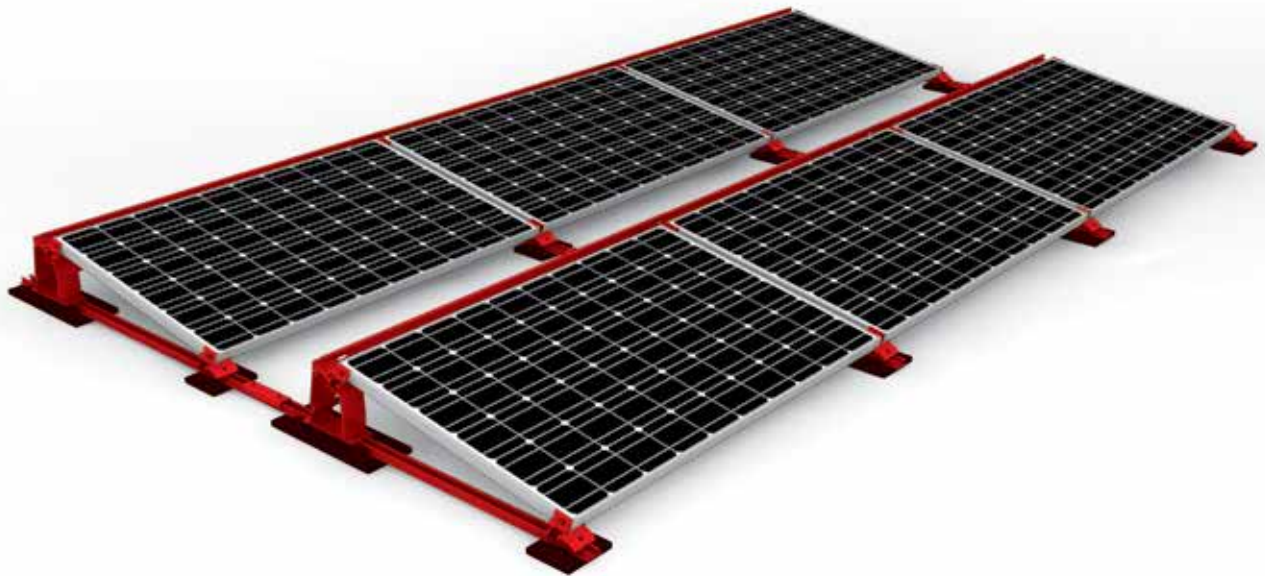

Ready!

## THANK YOU FOR CHOOSING A K2 MOUNTING SYSTEM.

Systems from K2 Systems are fast and simple to install. We hope these instructions have helped you in this. Please contact us if you have any questions or suggestions for improvements. All contact details can be found at:

<http://www.k2-systems.uk.com/contact.html>

Our General Terms of Business apply. Please refer to <http://www.k2-systems.com/en/gsc.html>. German Law shall apply excluding the UN Convention on CISG. Place of venue is Stuttgart.



Mounting systems for solar technology



SERVICE-HOTLINE  
**+49 (0)7159 42059-0**  
info@k2-systems.de

Montageanleitung S-Level Dome | GB6 | 1014 | Subject to change.  
Product illustrations are exemplary illustrations and may differ from the original.

